

NOT SHOWN:  
-----

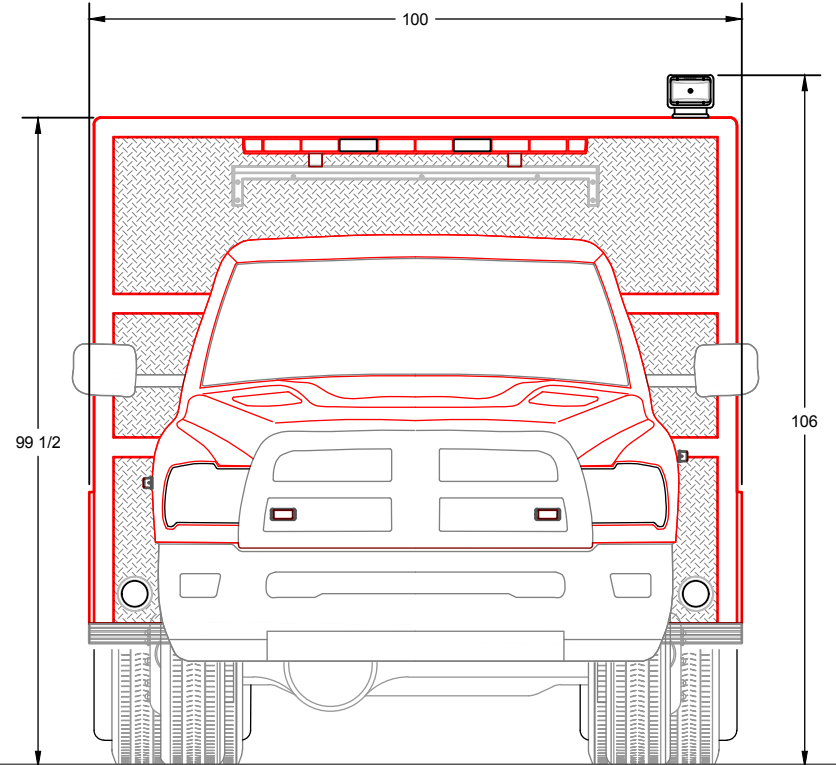

1	update to shop order	TEC	03-05-18
0	FIRST ISSUE	-----	-----
REV	DESCRIPTION	BY	09-02-16
REVISIONS			

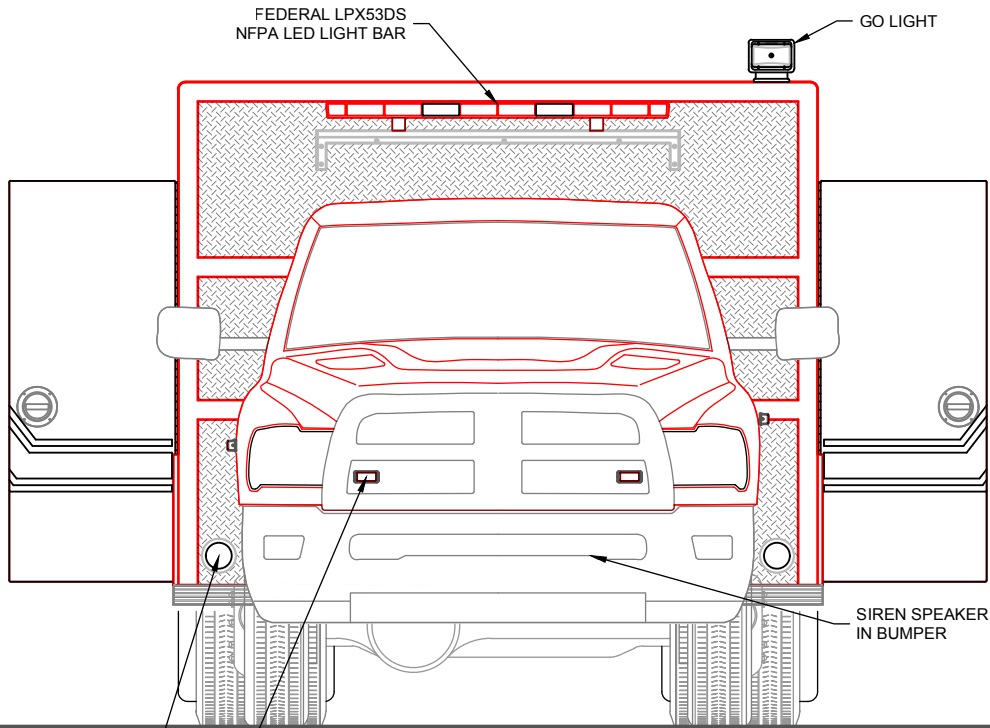

847 Central Street  
Centreville, NB  
E7K 2E8  
1-800-561-0012  
info@metalfabfiretrucks.com

CUSTOMER:

CITY OF ST. JOHN'S  
FIRE DEPARTMENT

DRAWN BY  
E SMITH

WO #20140

DATE  
12-12-17

CHASSIS: DODGE RAM 5500 2DR 4X4  
PUMP: N/A  
TANK: N/A Imp. Gal. POLYPROPYLENE  
FOAM: N/A

TITLE

FRONT

DRAWING NO.

FT-10612 OPT2

SHEET 1 OF 4

REV  
2

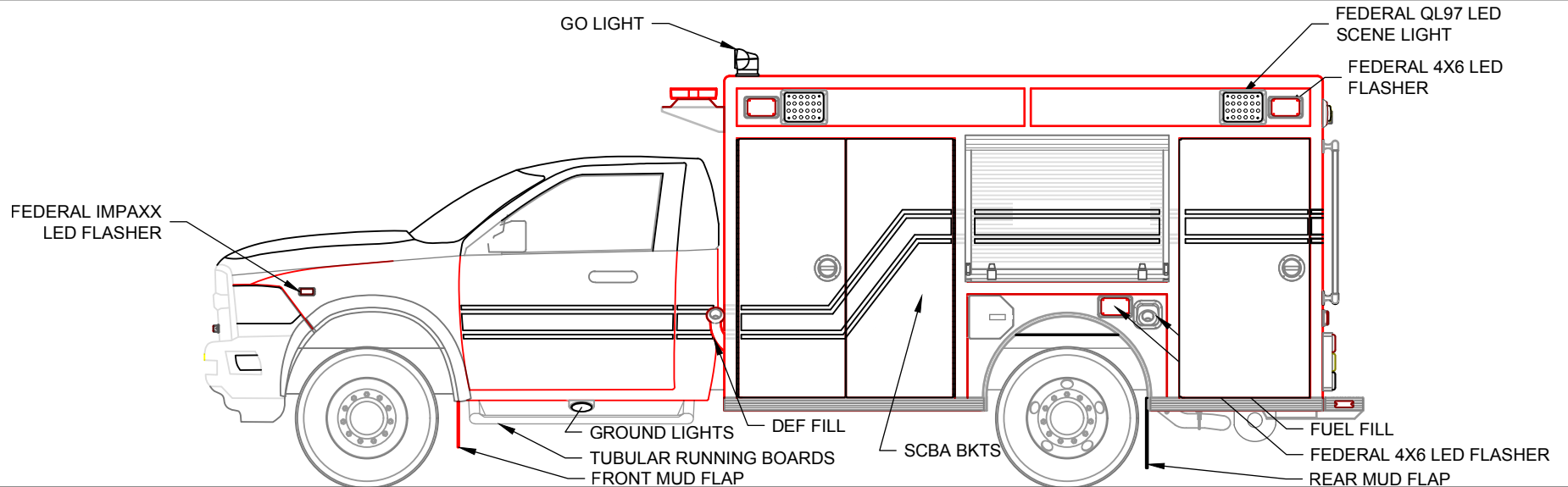
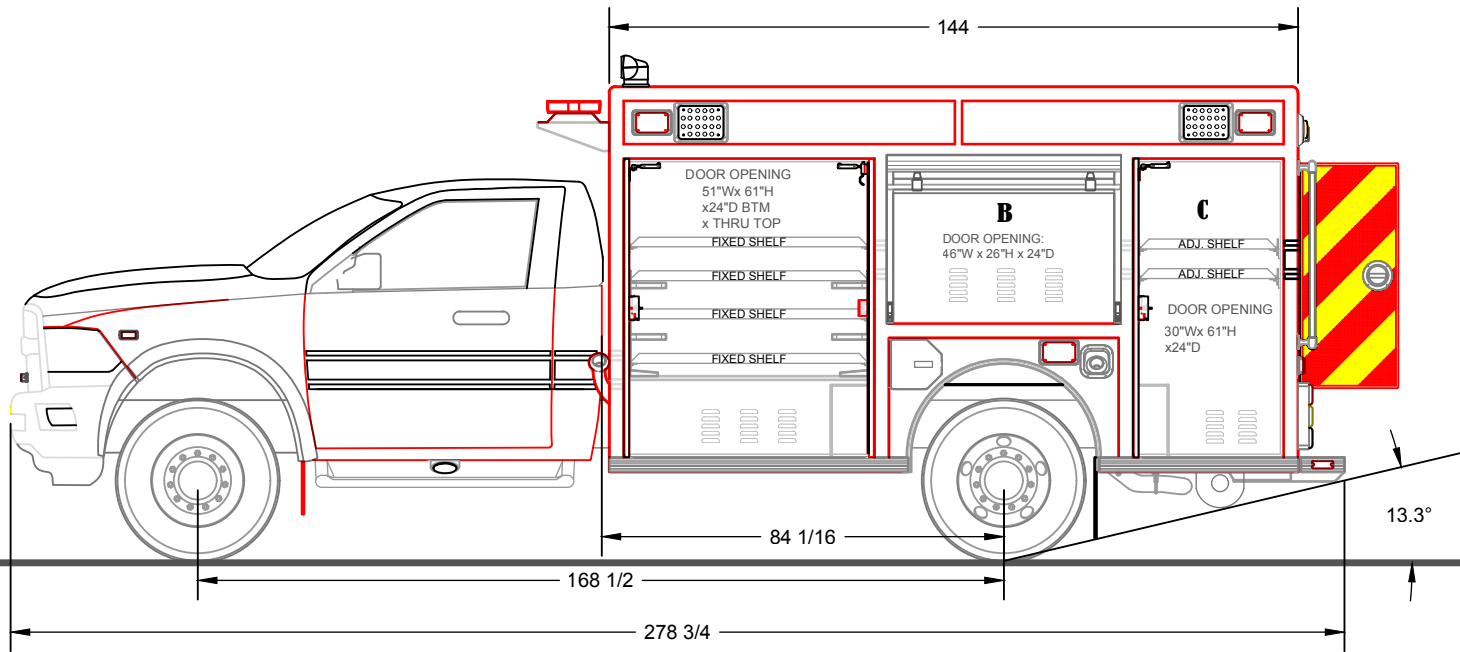

847 Central Street  
 Centreville, NB  
 E7K 2E8  
 1-800-561-0012  
 info@metalfabfiretrucks.com

CUSTOMER: CITY OF ST. JOHN'S  
 FIRE DEPARTMENT

DRAWN BY: E SMITH  
 DATE: 12-12-17

WO #20140

TITLE: LEFT SIDE

DRAWING NO.: FT-10612 OPT2

SHEET 2 OF 4

REV 2

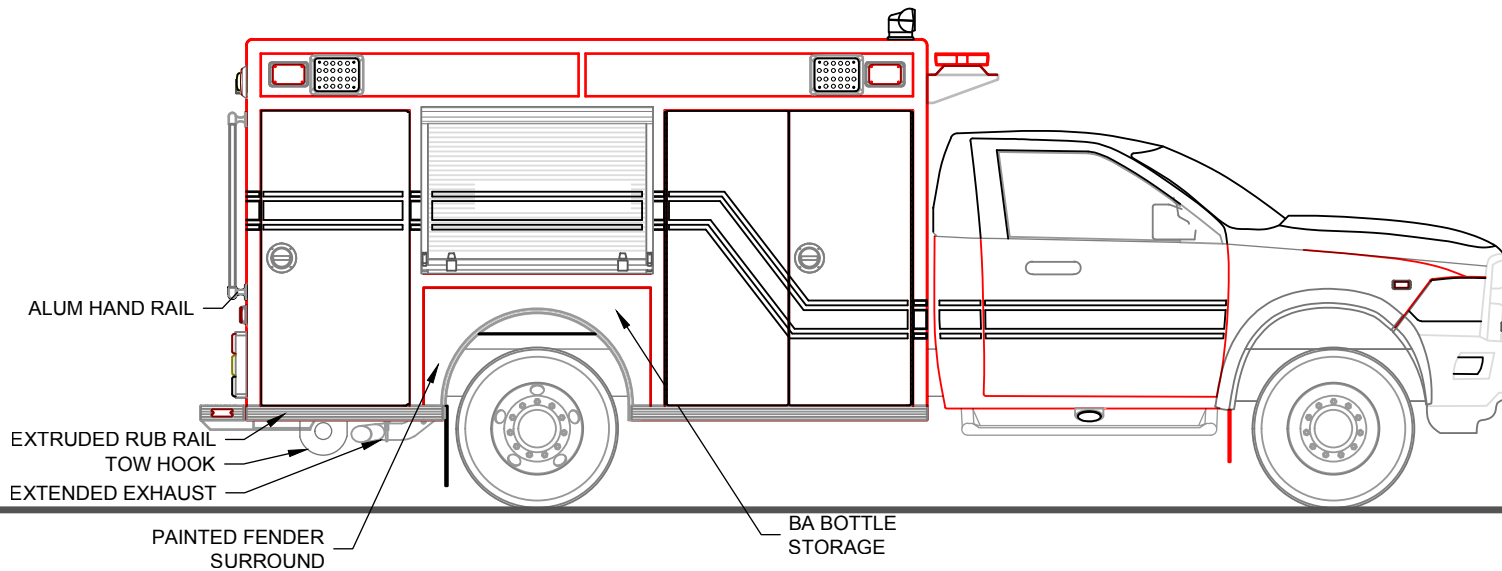
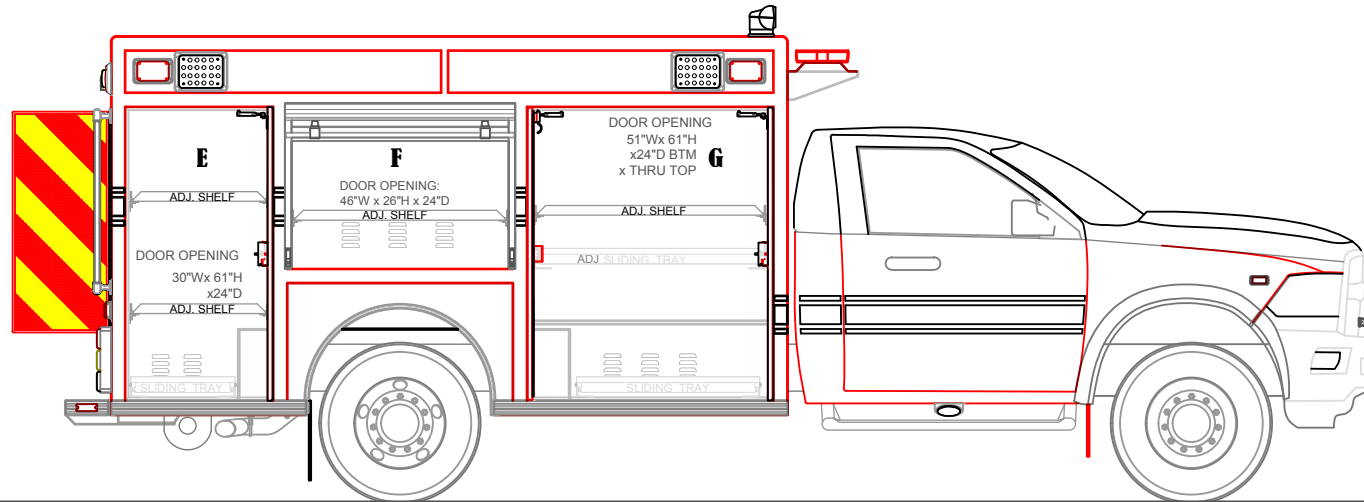

847 Central Street  
 Centreville, NB  
 E7K 2E8  
 1-800-561-0012  
 info@metalfabfiretrucks.com

CUSTOMER: CITY OF ST. JOHN'S FIRE DEPARTMENT	
DRAWN BY: E SMITH	WO #20140
DATE: 12-12-17	

TITLE: RIGHT SIDE
DRAWING NO.: FT-10612 OPT2
SHEET 3 OF 4

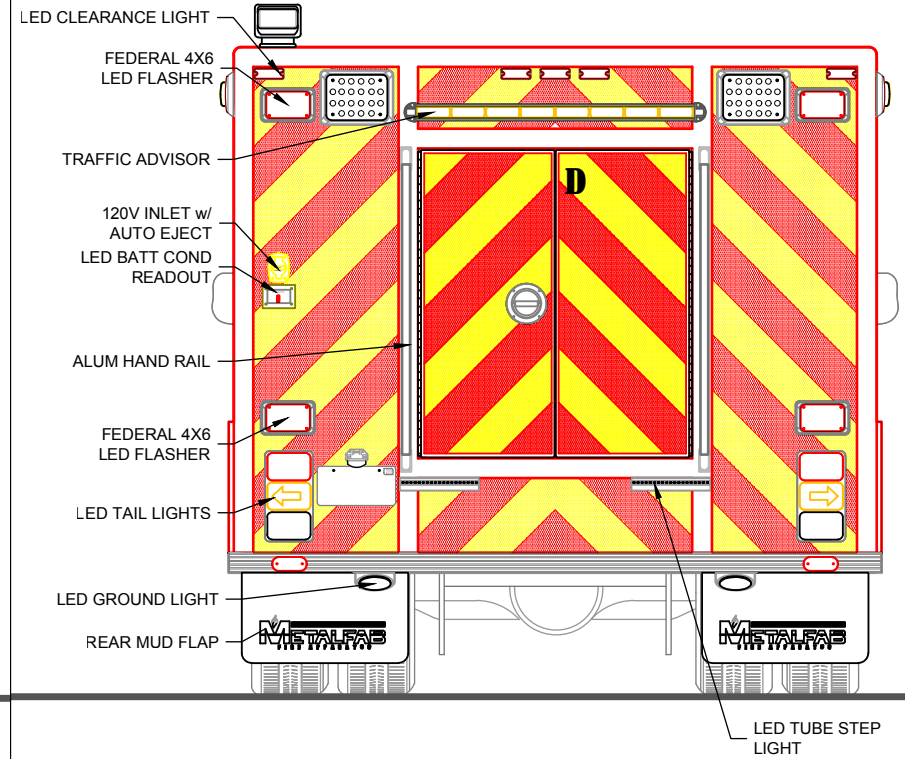
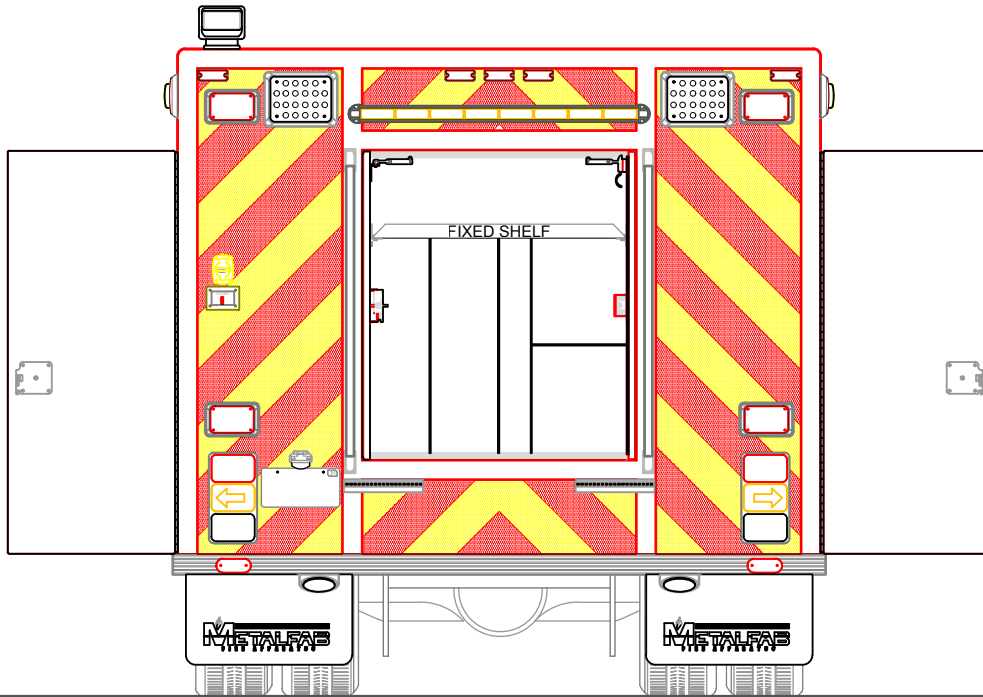

847 Central Street  
 Centreville, NB  
 E7K 2E8  
 1-800-561-0012  
 info@metalfabfiretrucks.com

CUSTOMER: CITY OF ST. JOHN'S  
 FIRE DEPARTMENT

DRAWN BY: E SMITH

DATE: 12-12-17

WO #20140

TITLE: REAR

DRAWING NO.: FT-10612 OPT2

SHEET 4 OF 4

REV 2